

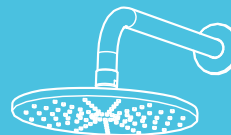

Hamwells®



Blue

User manual

2021 V1.6

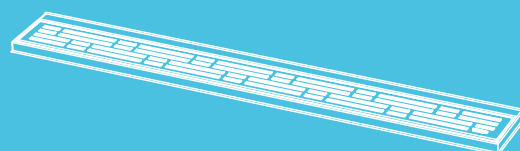
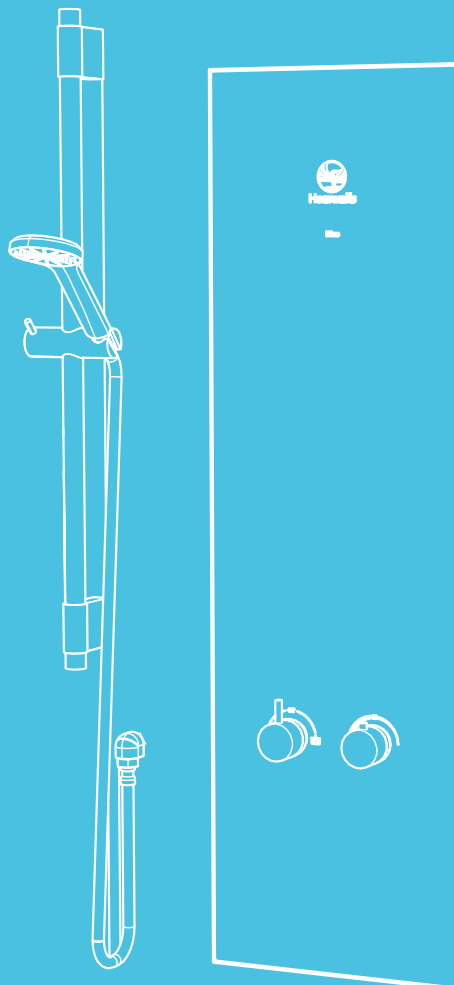

EN

Introduction to the Blue

Hamwells' Blue is a shower system with integrated heat exchanger module. This module extracts the energy from waste water and heats up the cold water after which you mix the water at the right temperature with your mixer tap. As a result, the shower uses very little hot water, while you still enjoy your shower in a sustainable and comfortable way. We strongly recommend that you read this user manual carefully before using the Blue. Save this manual for future reference.

Copyright

This document is protected by copyright and any reproduction of all or part of it is strictly prohibited except with the written permission of Hamwells Nederland B.V.

The content of this document is subject to change without notice. All technical information in this document is for reference purposes only. The illustrations in this manual may differ from the products supplied. All drawings and diagrams are for illustrative purposes only.



Safety instructions

Check to see if the product is complete and free from damage. If there are signs of damage or parts are missing, please contact us.

Hamwells Nederland B.V.

Pelgrimsstraat 3, 3029 BH Rotterdam

T +31 85 303 6496

E info@hamwells.com

I www.hamwells.com

Our telephone service is available from Monday to Friday from 09:00 to 17:30 (CET), except on public holidays.

- Never attempt to repair, disassemble or make modifications to this product.
- Only qualified engineers should carry out repair and maintenance with original replacement parts with the prior written approval from the manufacturer.
- Always supervise children and persons with special needs during use of the Blue.
- Before each use of the Blue, check the temperature setting of the water.
- If you have filled a baby bath using the hand shower, use a thermometer to check whether the water has the correct temperature!

Cleaning procedures

To keep the Blue in perfect condition we advise you to clean the shower on a regular basis. The use of aggressive detergents like acetone or thinner is not recommended! We advise you to cleaning vinegar to clean the glass panel. The table below shows a maintenance summary.

Action	How often
Glass panel*	Weekly
Grid and filter plate*	Weekly
Shower tray*	Weekly
Check EA valves	Yearly
Maintenance EB valves	Every 10 years

**This can vary by household.*

Parts

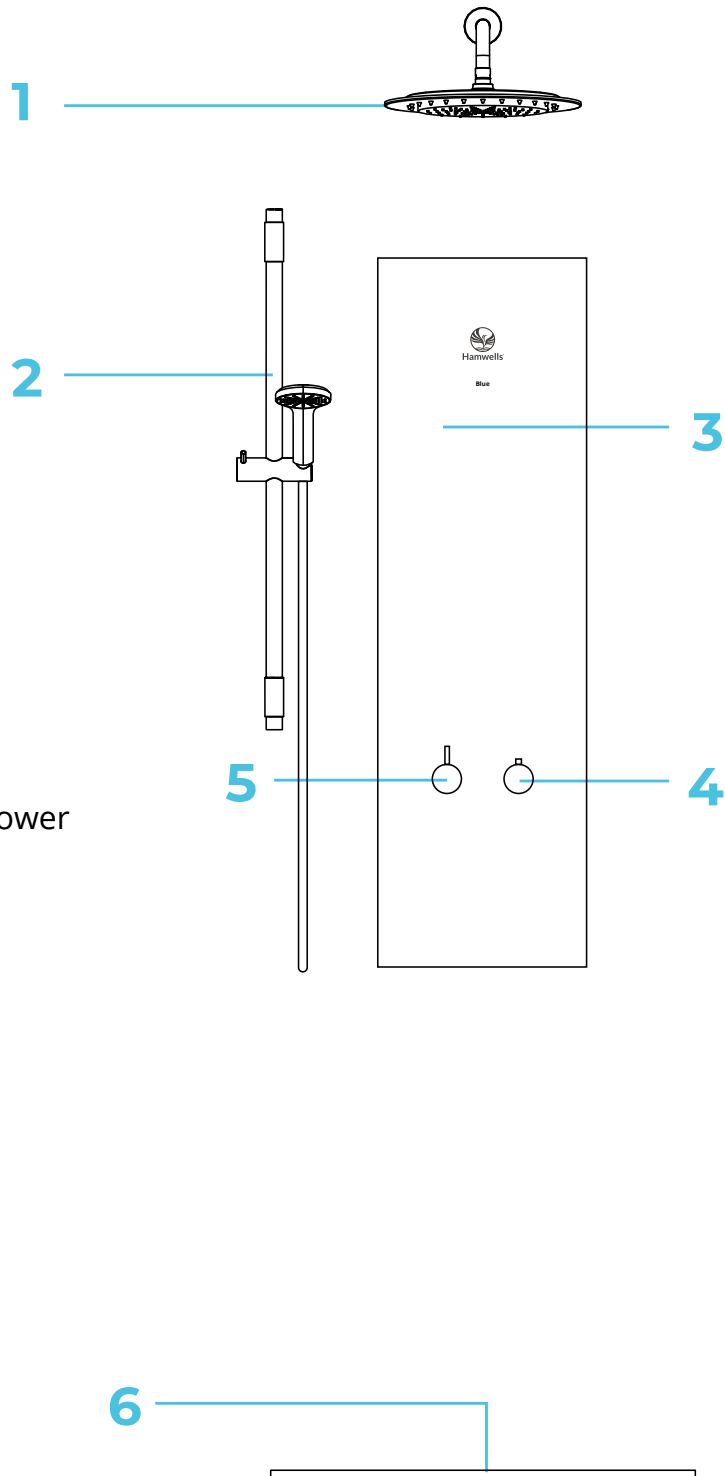

- 1. Main shower
- 2. Hand shower
- 3. Frontpanel
- 4. Control knob temperature
- 5. Control knob hand/main shower
- 6. Drain

Operating the Blue

The operation of the Blue is fairly simple and works just like a conventional shower. You can adjust the temperature by turning the control knob.

Turn the right control knob to the left to raise the water temperature. If you wish to set a temperature over 38 °C, you should press the button on top to unlock the temperature lock.

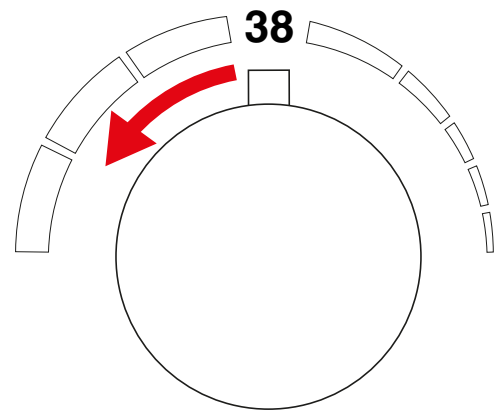

Turn the control knob to the right to lower the water temperature.

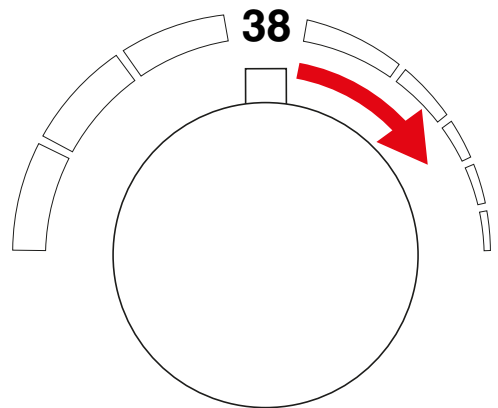

Turn the left control knob to the left to select the hand shower.

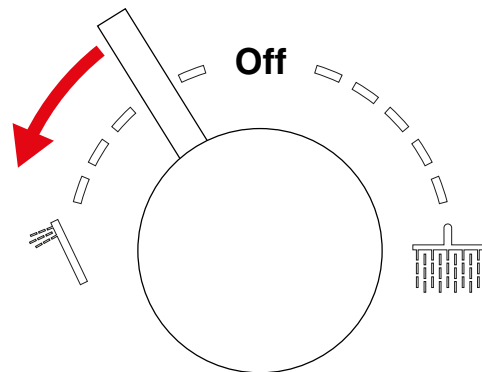

Turn the left control knob to the right to select the main shower.

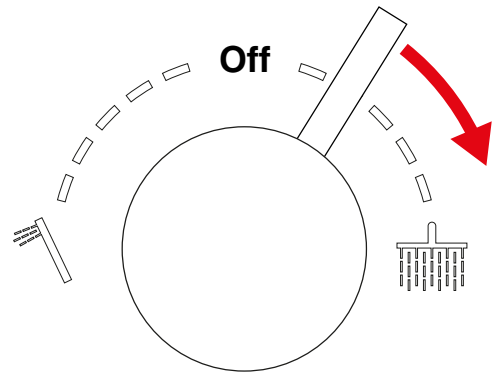

Turn the left control knob to the centre to switch off the Blue.

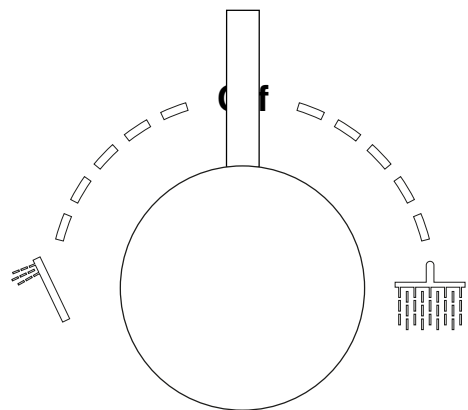

When using the Blue for the first time or when the power mains has been switched off you will hear the pump pumping out the water in the siphon. This will take about 20 seconds after which the pump unit is calibrated. You might also hear this sound after the Blue is switched off.

Hamwells Nederland B.V.

Pelgrimsstraat 3, 3029 BH Rotterdam, The Netherlands

T +31 85 303 6496

E info@hamwells.com,

I www.hamwells.com

© 2021 Hamwells Nederland B.V. All rights reserved!

